



After you've set up your iMac and followed the onscreen guide to register your computer and set up an Internet account and e-mail address, what's next? Read this booklet to learn more about using your iMac:

- 2 Features
- 4 Basics
- 6 Internet and e-mail
- 12 Software
- 18 Installing memory and an AirPort Card
- 20 Learning more and solving problems
- 24 Ergonomic and safety information



What are the features of my iMac?

Your computer has these built-in capabilities:



CD-ROM or DVD-ROM drive

Install software, use applications, and listen to music CDs. If your computer has a DVD drive, you can also play DVD videos.

Two headphone ports

Connect one or two pairs of headphones to your computer.

Microphone

Record sound and give spoken commands to your computer.

Power button

Turn your computer on or put it to sleep.

Two internal stereo speakers

Listen to CD-quality music or movies, games, and multimedia.

 **Modem**
Connect to the Internet, browse the World Wide Web, and send and receive electronic mail.

 **FireWire**
(on some models)
Connect high-speed devices such as digital video cameras, disk drives, printers, and scanners.

 **Sound input**
Record sounds using an analog microphone or other audio device.

 **Sound output**
Connect headphones, external speakers, and analog audio devices.

 **Reset button**
Use during troubleshooting to restart your computer.

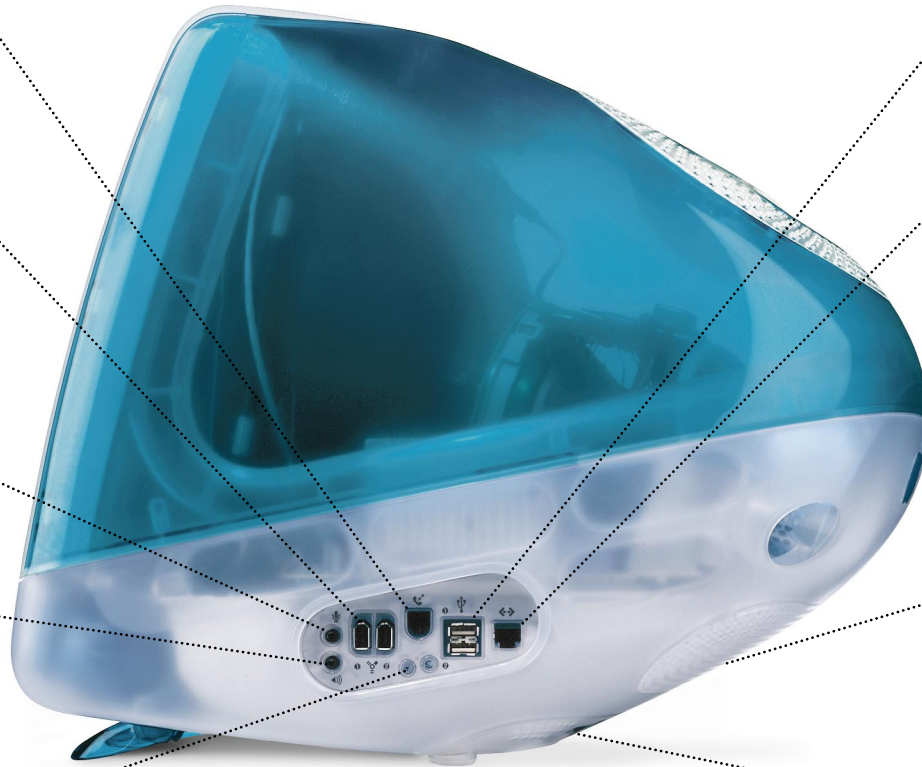

 **USB**
Connect printers, disk drives, digital cameras, digital speakers, joysticks, and more.

 **Ethernet**
Share files with another computer and access a computer network, printer, or the Internet.

VGA output
(on some models)
Connect an external monitor or television for video mirroring. Some TVs may require a scan rate converter.

Access door
Install additional memory and an AirPort Card for wireless networking.

What are the basics?

The Macintosh desktop is your starting place.

The image shows a classic Macintosh desktop environment with a yellow honeycomb pattern. A Finder window is open, displaying the 'About This Computer' menu. The menu items include: Apple DVD Player, Apple System Profiler, Calculator, Chooser, Control Panels, Favorites, Key Caps, Network Browser, Recent Applications, Recent Documents, Remote Access Status, Scrapbook, Sherlock 2, and Stickies. The desktop contains icons for 'Macintosh HD', 'Browse the Internet', 'Mail', and 'Trash'. The menu bar at the top shows 'File', 'Edit', 'View', 'Special', and 'Help'. The Control Strip at the bottom contains various system icons like volume, network, and power.

Apple menu
Use this to select commonly used applications and tools. To see the menu, press the apple (🍏) in the menu bar.

Application menu
Look here to see which application you are using or to switch between open applications.

Browse the Internet
Double-click (click two times quickly) this icon to open your preferred World Wide Web browser.

Mail
Double-click this icon to open your preferred e-mail application.

Trash
Drag items here to delete them. Items remain here until you choose Empty Trash from the Special menu.

Control Strip
Use this for convenient access to commonly used settings.

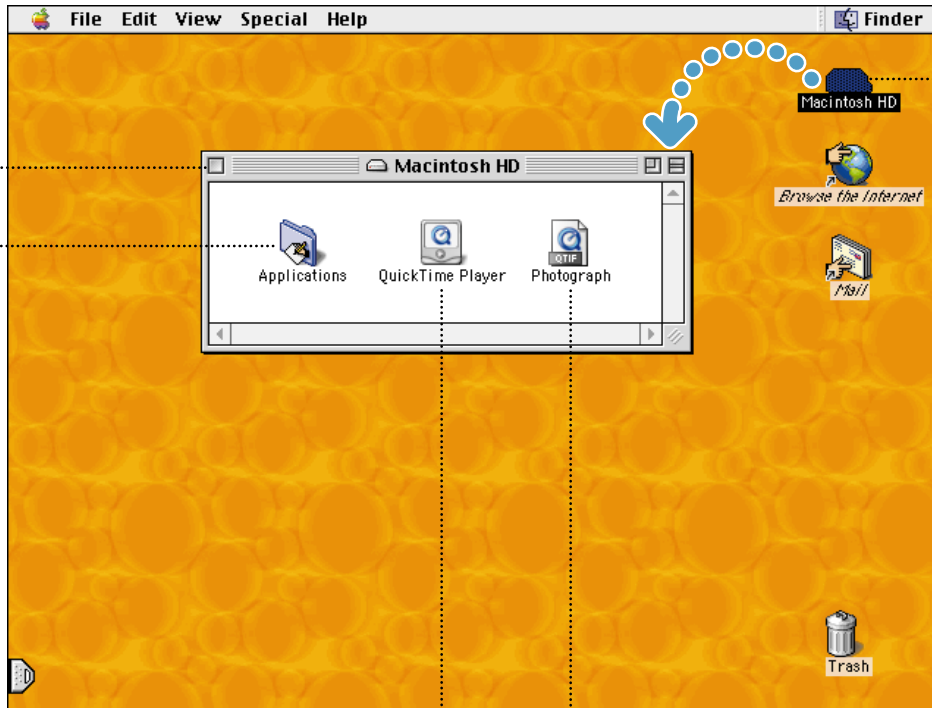

Close box

Click this to close a window.

Folder

You create folders to help organize your files and programs. Double-click a folder to open it.

Hard disk

All of your files and applications are kept here. Double-click the icon to open it.

Application

Applications are software programs (such as a game or word processor) that you use with your computer. Double-click an application's icon to open the application.

Document

Documents are files that you create with an application (such as a letter you create with your word processor). Double-click a document's icon to open the file and to view, edit, or print it.

How do I find something on the Internet?

Use Sherlock 2 to quickly search the Internet.

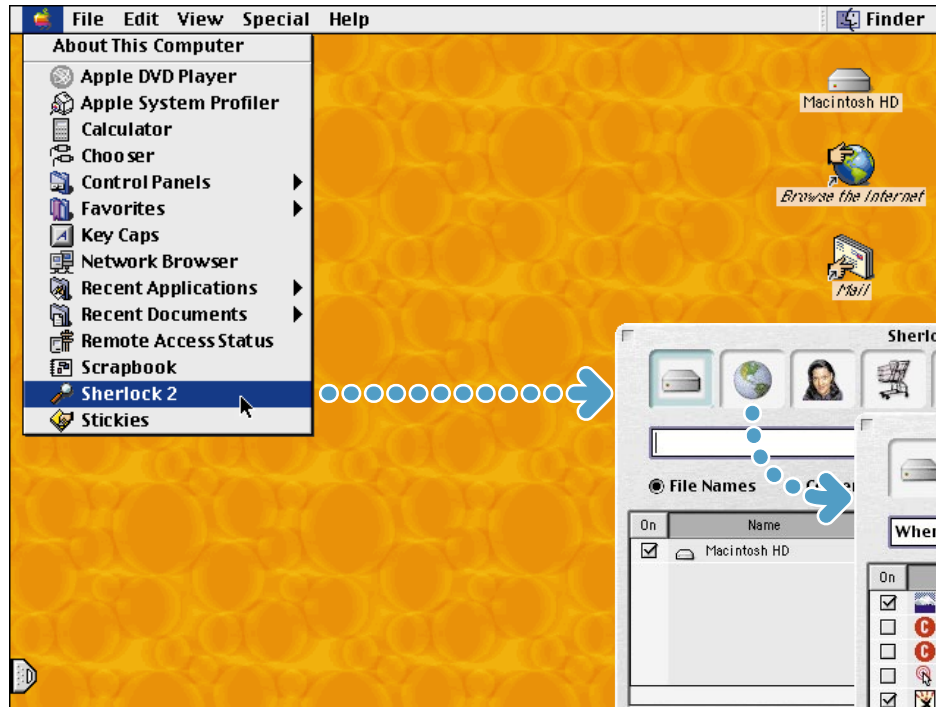

2 Type what you want to find and click Search.



1 Open the Apple (🍏) menu and choose Sherlock 2. Then click the Internet button.



3 Double-click an item in the list of Internet sites that Sherlock 2 found.



► Listed items are ranked by relevance. The longer the bar, the more likely an item is to contain what you're looking for.

How do I go to a place on the Internet?

All you need to know is the Internet address.

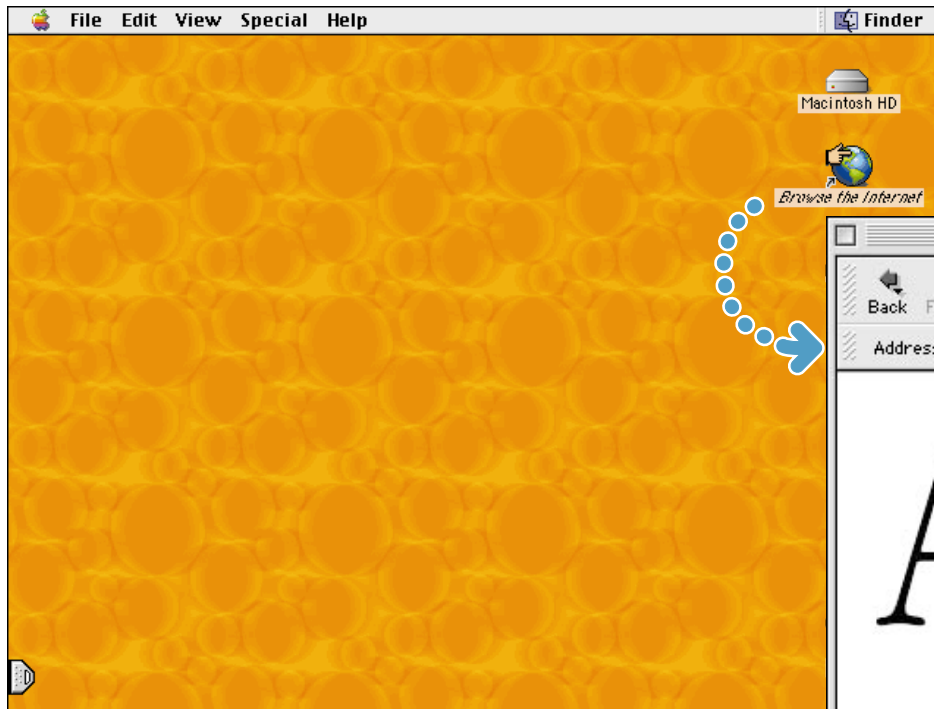

2 Type the Internet address and press Return on your keyboard.

1 Double-click "Browse the Internet" to open your Web browser.

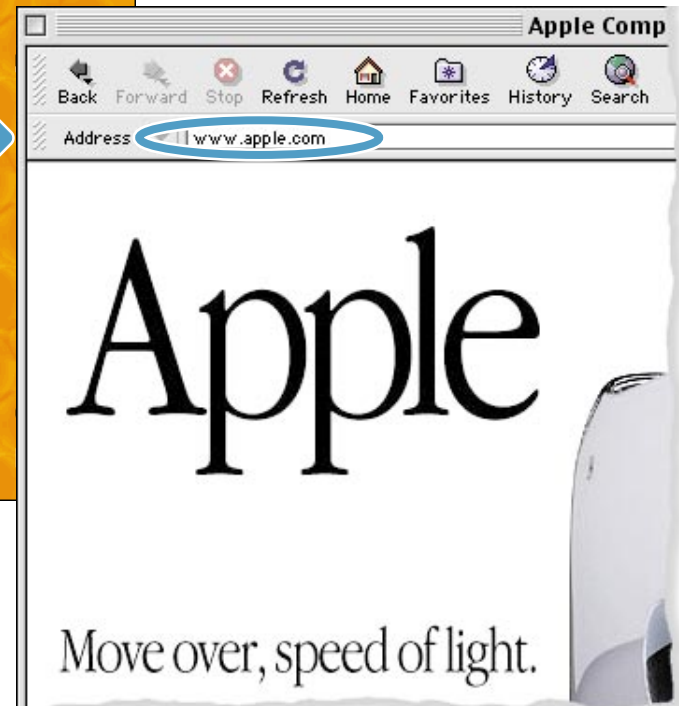

These Apple Web sites will help you get the most out of your computer.

► From these Web sites you can quickly link to other Apple Web sites around the world.



www.apple.com/imac

News and information specifically for iMac users.

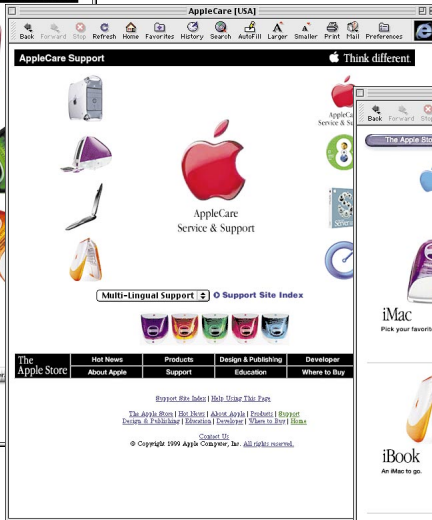

www.apple.com/support

Visit here for product support, software updates, and technical information.



www.apple.com/store

The latest Apple hardware, software, and accessories.

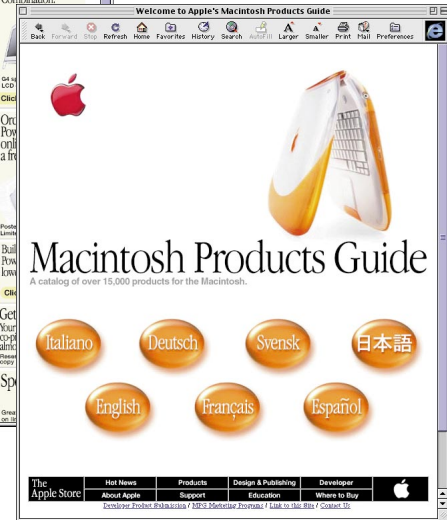

www.apple.com/guide

Find out about over 15,000 hardware and software products available for the Macintosh.

How do I use e-mail?

Follow these steps to create and send a message:

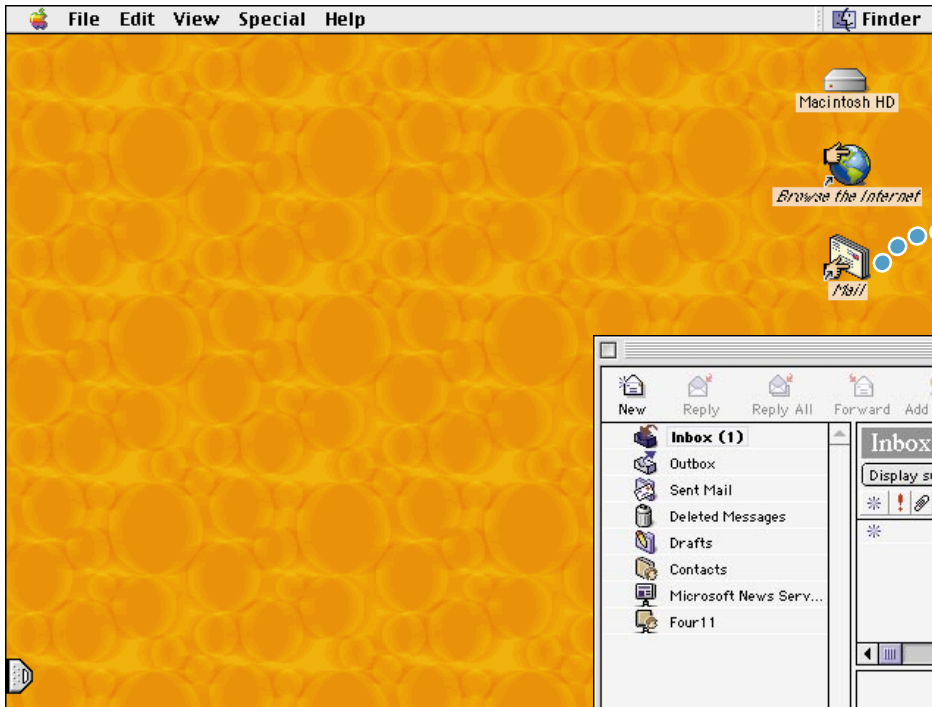

1 Double-click the Mail icon on the desktop to open your preferred e-mail application.

▶ To check for new messages, click the Send & Receive button. To view a message, click its subject.

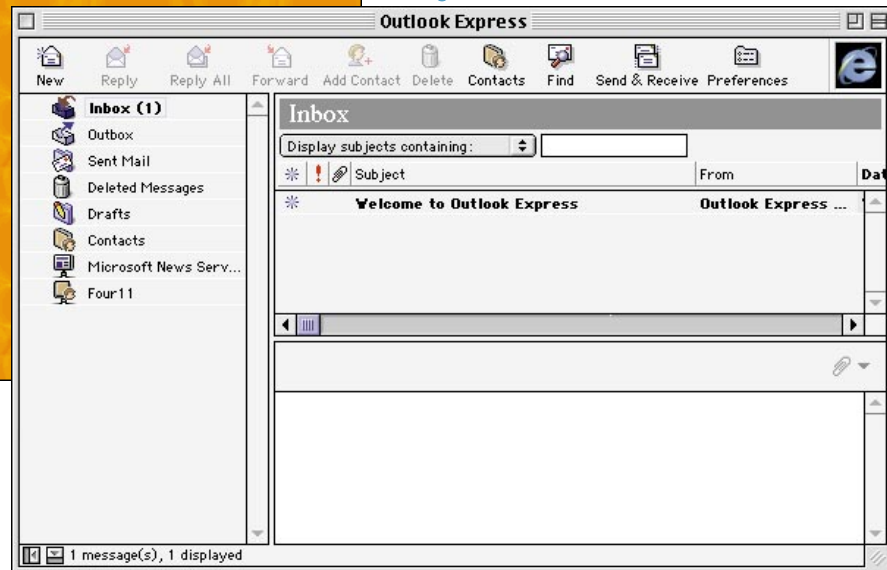

2 To create a new e-mail message, click the New button.

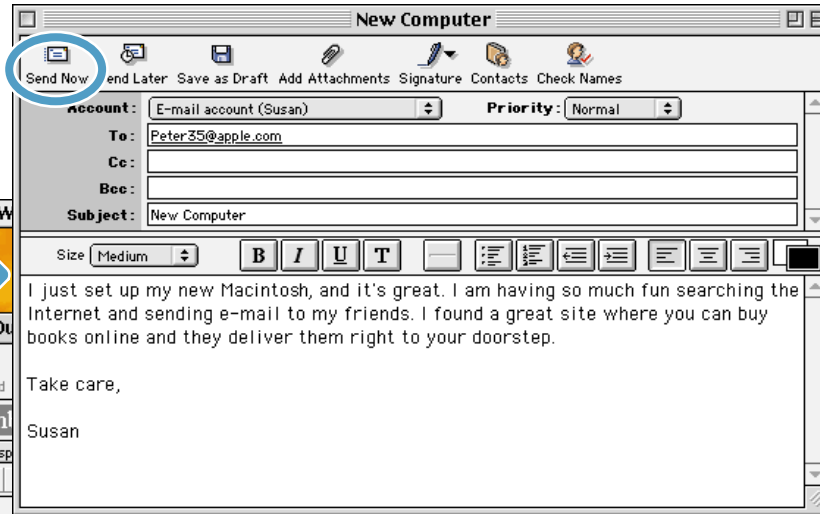
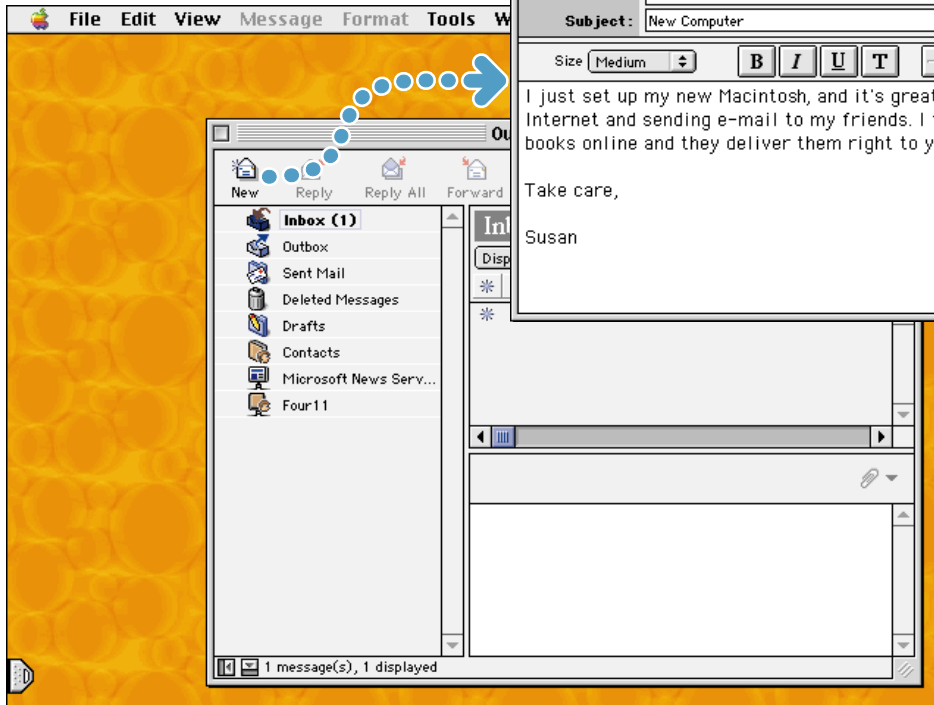

3 Type the e-mail address and a brief subject. Then type your message and click Send Now.

What about software?

Your computer comes with many software applications.

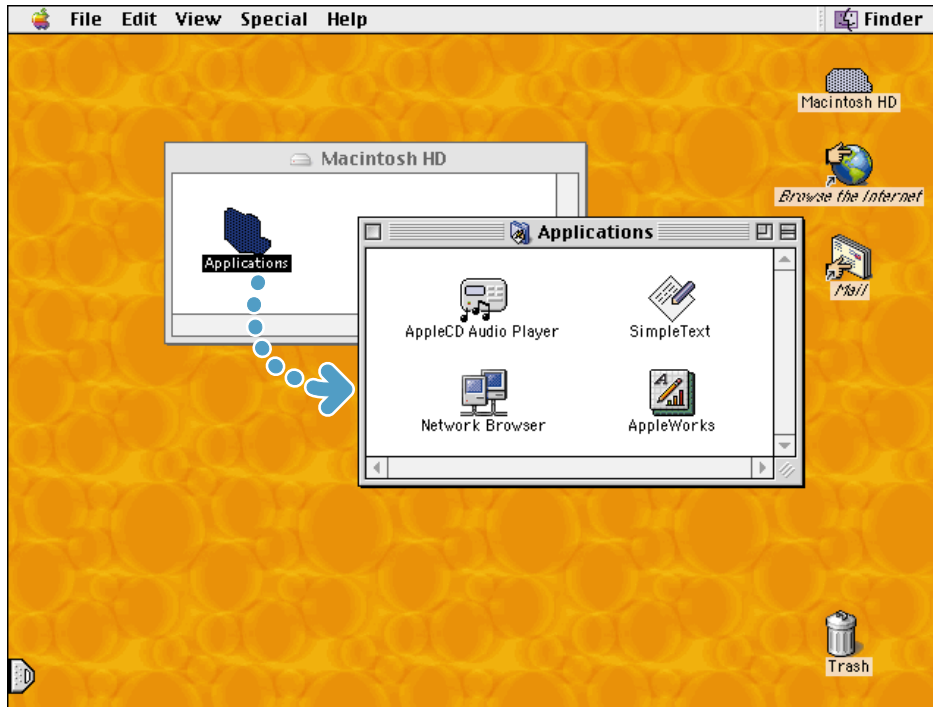

1 Open the Applications folder on your hard disk.

2 Double-click the application you want to open.

- ▶ Some applications are preinstalled in the Applications folder; you need to install others yourself. See the software list in your accessory kit.
- ▶ To use some applications, you need to insert the disc in the CD or DVD drive slot.
- ▶ On models with a DVD drive, the Apple DVD Player is preinstalled and accessible from the Apple () menu.

You can use AppleWorks for writing, drawing, painting, and much more.

Sophisticated layout capabilities

Add photos, tables, charts, and sidebars. Link text frames, layer graphics, and wrap text like a pro.

Extensive clip art libraries

Easily add compelling graphics and photos to your document.

State-of-the-art word processing

Enjoy everything from a built-in thesaurus to automatic hyphenation.

Hypertext linking

Create hypertext links within or between documents, and even link to the Web.

The screenshot shows a document window with a title bar and standard Mac OS window controls. The document content is a news article about butterflies. At the top, a green banner contains the title 'Butterfly Society News' in large, bold, orange letters. Below this is the main headline 'Butterflies return to Monterey' in a large, bold, black font. The article is laid out in a two-column format. The left column features a photograph of a monarch butterfly with its wings spread, set against a light blue background. The right column contains a table titled 'Butterfly' showing monthly counts for Monarch, Viceroy, and Satyr butterflies from March to August, with a 'Sub-total' row showing 1265 Monarchs, 1284 Viceroys, and 1557 Satyrs. Below the table is a pie chart titled 'Butterfly Counts' showing the distribution: Monarch (37.9%), Viceroy (31.3%), and Satyr (30.8%). The article text is in a classic serif font, with some words in all caps. At the bottom of the document, there is a text box with a yellow background containing a Latin sentence: 'Nam cum antea per aetatem nondum huius auctoritatem loci attingere auferem, statueremque nihil huc nisi perfectum. Putatisne vos illis rebus frui posse, nisi eos qui vobis fructui. sunt.' The status bar at the bottom of the window shows '100' on the left, a small icon in the middle, and 'Page 1' on the right.

Butterflies return to Monterey

Butterfly			
	Monarch	Viceroy	Satyr
March	304	178	254
April	78	39	75
May	140	315	266
June	148	253	316
July	234	208	310
August	261	291	336
Sub-total	1265	1284	1557
Total			4106

Butterfly Counts			
	Monarch	Viceroy	Satyr
Monarch	37.9		
Viceroy		31.3	
Satyr			30.8

Nam in cretibus rebus cum venit calamitas, tum aduentus dor detrimetum accipitur, at in vertigibus non solum ut aduentus mali, sed etiam metus ipse adfert venit calamitatem. Nam cum hostium coplace non longe absent, etiam si inruptio nulla facta est, tamen

Nam cum antea per aetatem nondum huius auctoritatem loci attingere auferem, statueremque nihil huc nisi perfectum. Putatisne vos illis rebus frui posse, nisi eos qui vobis fructui. sunt.

Customizable templates

Choose from a wide range of predesigned document types and modify them as needed.

Powerful spreadsheets

Compute data easily using over 100 built-in functions, then use advanced formatting options to make your data really stand out.

Professional charts and graphs

Create great-looking line, bar, and pie charts with ease.

To get started using applications such as AppleWorks:

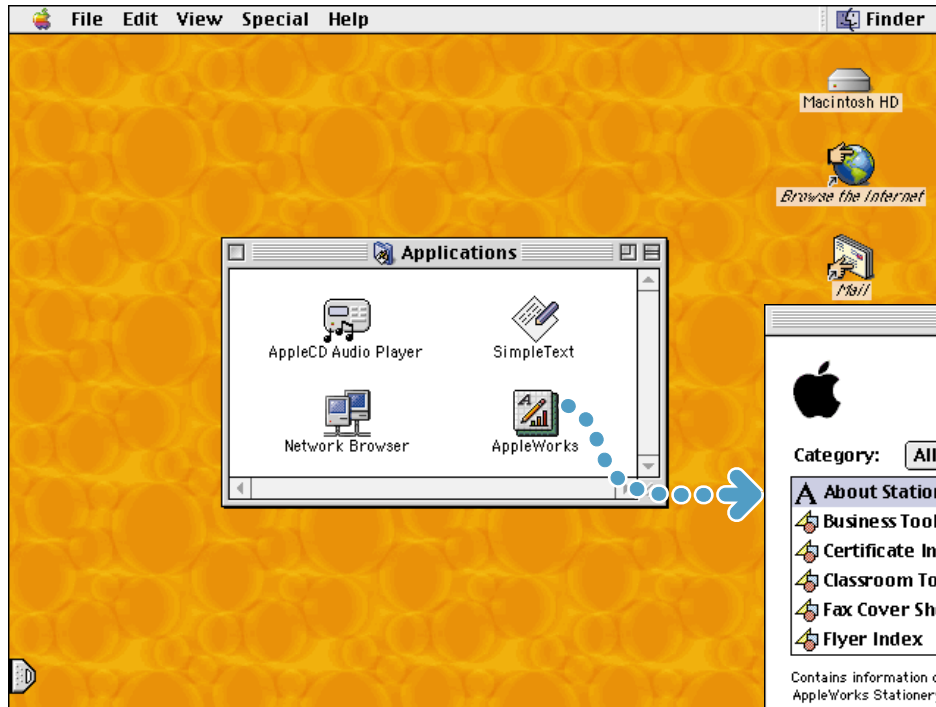

1 Double-click an application's icon to open the application.

▶ When you first use AppleWorks, you'll be asked to enter your name and company; your version doesn't require a serial number.

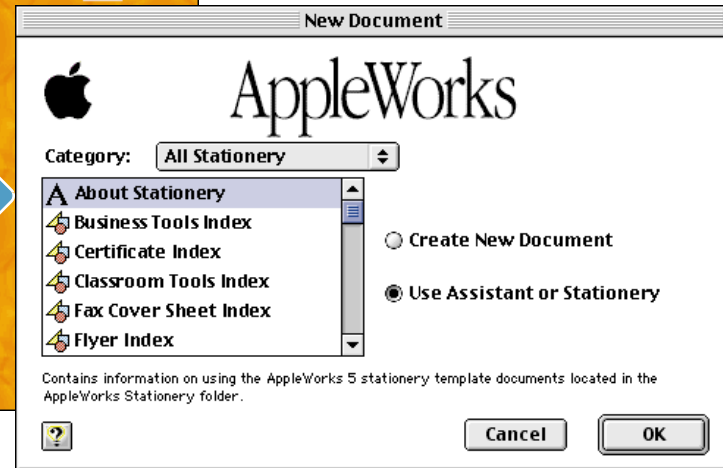

2 Select the type of document you want to create.

To learn more about AppleWorks, look

- at the AppleWorks electronic manual (on your hard disk in the AppleWorks folder)
- at the AppleWorks information in the Help menu
- on the AppleWorks Web site (www.apple.com/appleworks)

To install software that's on a CD:

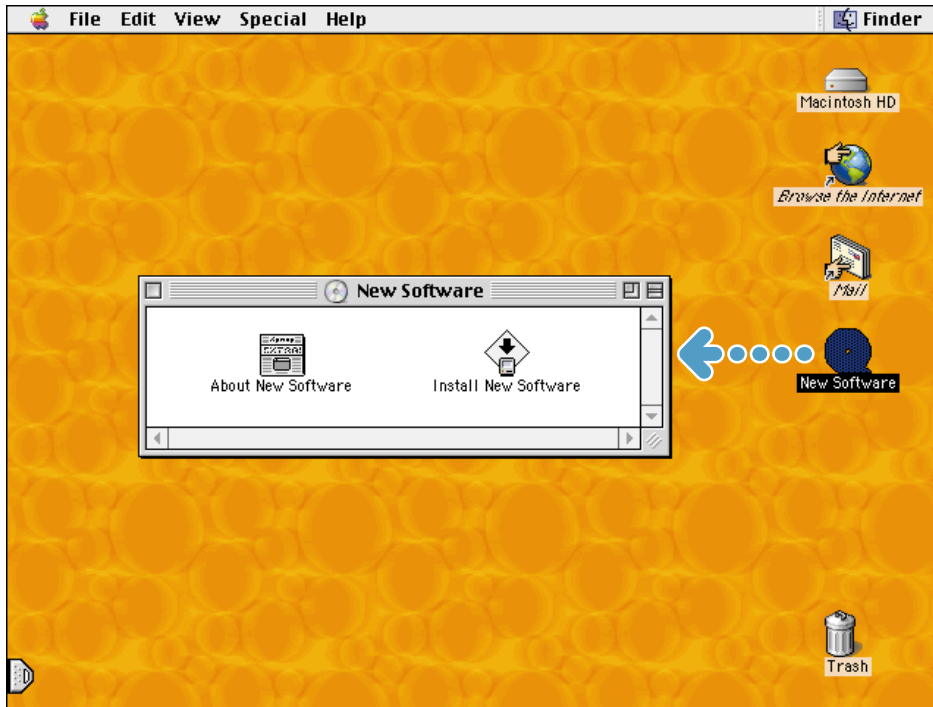

1 Insert the disc in the drive slot with the label facing up, then double-click the disc's icon to open it.

▶ CD-ROM discs can be used in DVD-ROM drives.

▶ Use only circular discs with your CD or DVD drive. Apple does not recommend the use of non-circular discs.

2 Double-click the installation application to install the new software on your computer.

3 When you're ready to eject the disc, drag the disc's icon to the Trash.

If your computer has FireWire:

You can create your own movies using iMovie and a digital camcorder.

Monitor window

Preview your movie or view video directly from a digital camera using the controls at the bottom of the window.

Full screen button

Click this to play your movie on the entire computer screen.

Mode switch

Use this to switch between camera and edit mode.

Viewer

Click the Clip Viewer tab to edit and place clips.

Click the other tab to open the Audio Viewer and edit sound effects.

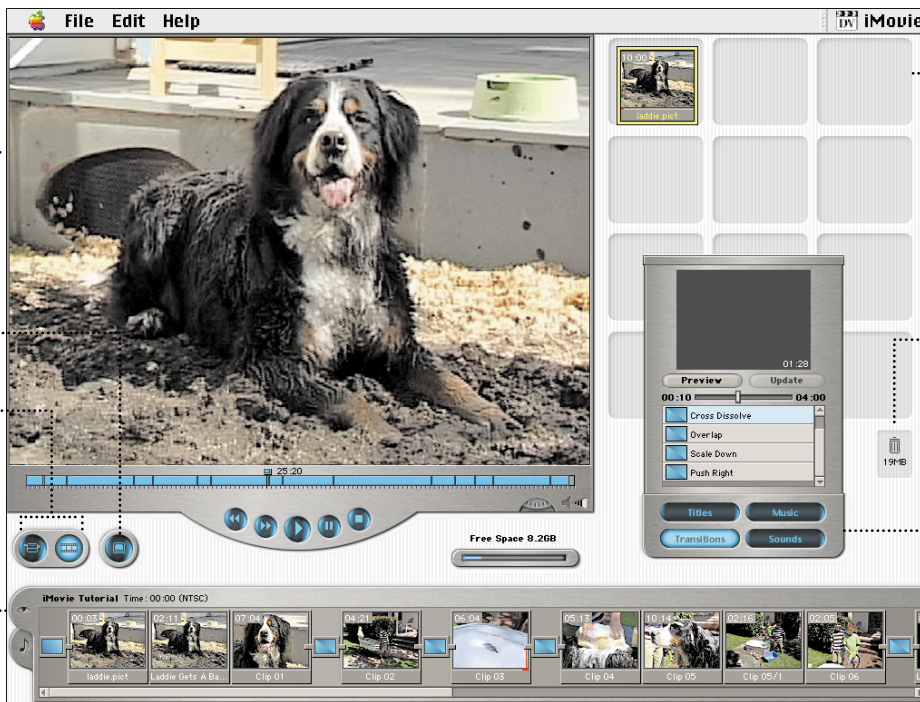

Shelf

Store clips you may want to use in your movie. To add a clip to your movie, drag it to the Clip Viewer.

Trash

Place unwanted clips here to delete them and create more hard disk space on your computer.

Effects palettes

Easily add titles, transitions, music, and sound effects.

► iMovie is installed in the Applications folder on your computer's hard disk (see page 12).

To learn more about iMovie:

- open the iMovie application, then go through the tutorial, available in the Help menu
- see iMovie Help, available in the Help menu
- go to the Apple iMovie Web site at www.apple.com/imovie

The Apple DVD Player lets you view DVD movies.

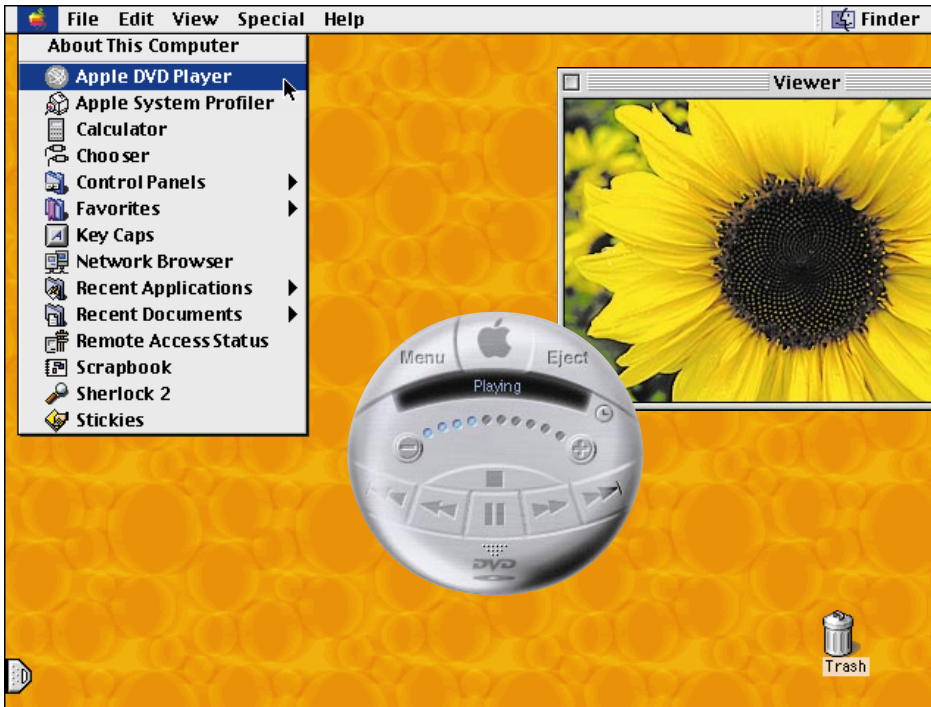

1 Insert a disc in the drive slot.
Then open the Apple (🍏) menu
and choose Apple DVD Player.

2 Use the controller to play the
movie in the Viewer window.

- ▶ You also use the controller to access special features of the movie.
- ▶ To learn more about the Apple DVD Player, look at the Apple DVD Player information in the Help menu.

How do I add memory and an AirPort Card?

For detailed instructions, refer to Mac Help (see page 20).

Before installing:

- shut down the computer
- unplug all cables, except the power cord
- place the computer face down on a soft cloth

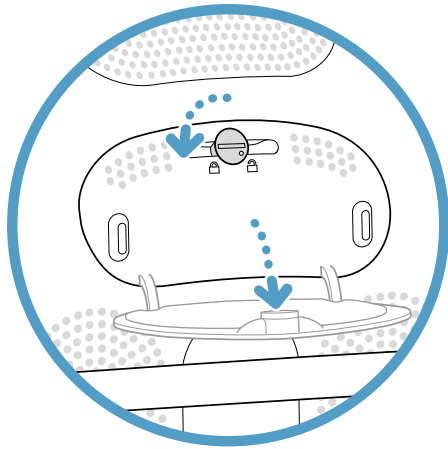

1 Open the access door using a coin to turn the latch.

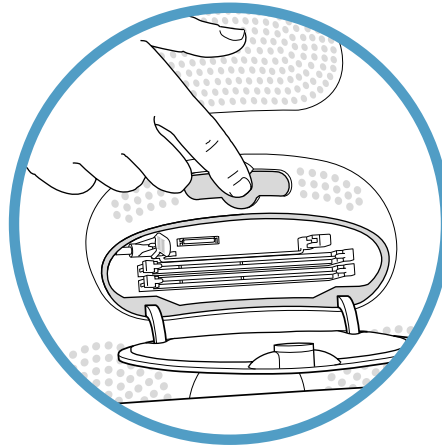

2 Touch the metal shield inside the recessed latch area. Then unplug the power cord.

- ▶ Touch this metal before you touch any parts inside the computer. Don't walk around the room until you've finished installing memory or an AirPort Card.

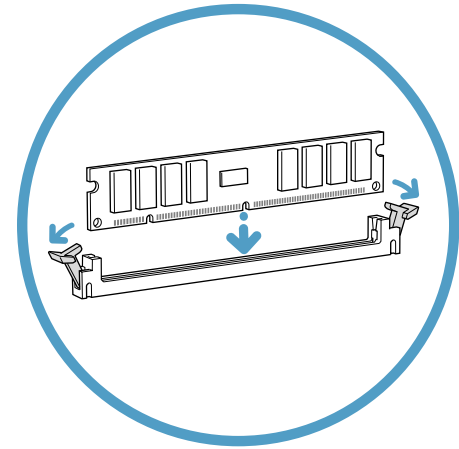

3 To install memory, insert a memory module into one of the two lower slots.

- ▶ Be sure to align the notches on the module with the small notches inside the slot.

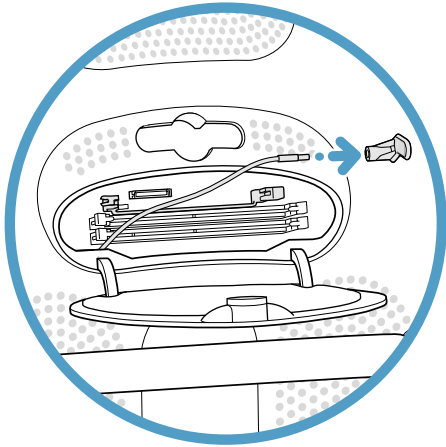

4 To install an AirPort Card, detach the antenna from the guide rail, then remove the protective plastic cap.

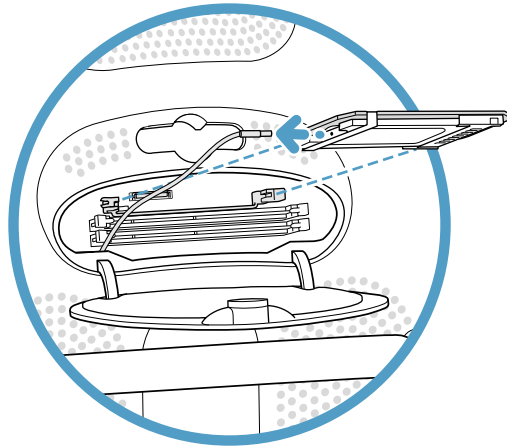

5 Then connect the antenna to the AirPort Card and insert the card sideways into the slot.

▶ For instructions on using the AirPort software, look in Mac Help, available in the Help menu.

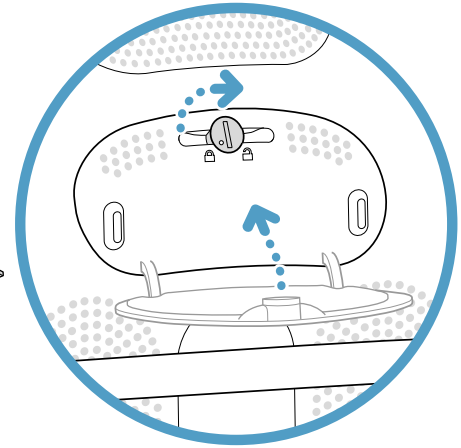

6 Close the access door and use a coin to close the latch.

▶ Never turn your computer on unless all of its internal and extra parts are in place.

Where do I go to learn more?

Look in Mac Help for more information on using your computer.

1 Choose Finder from the Application menu (see page 4).

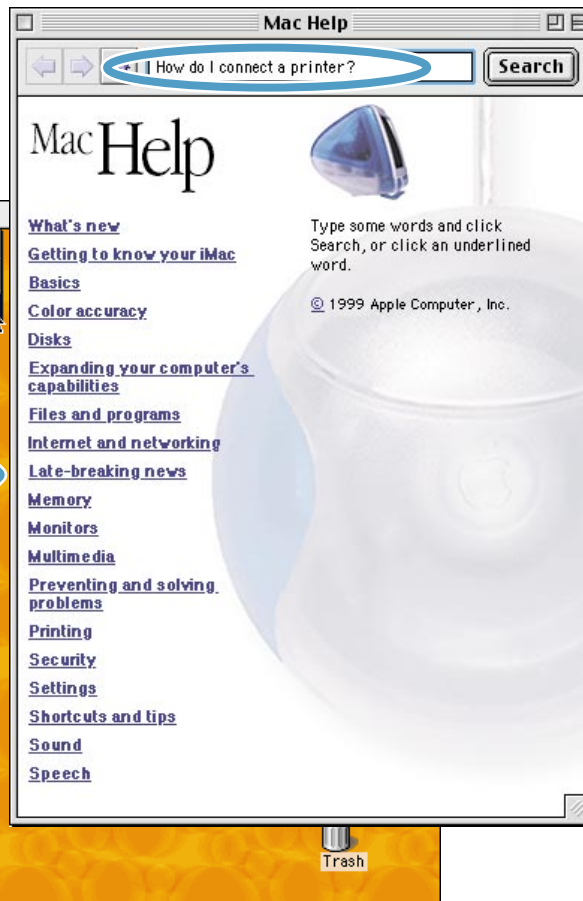
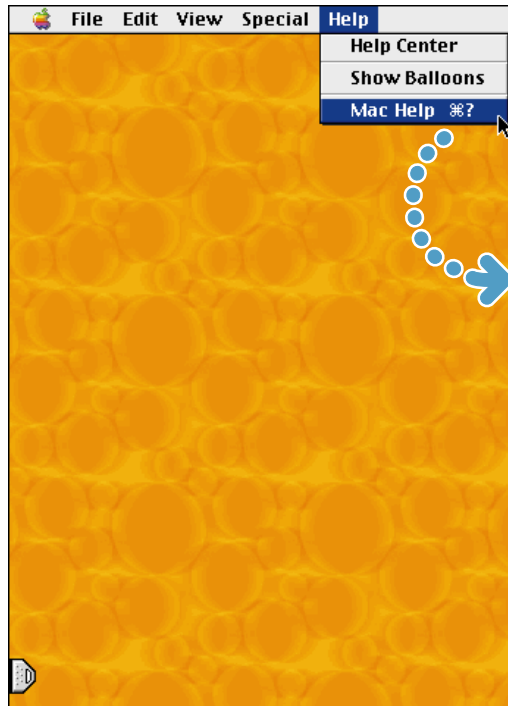

2 Open the Help menu and choose Mac Help.

3 Type a question or keywords, then click Search.

▶ You can also browse through information about your computer by clicking one of the blue underlined items in the window.

▶ To view Help for other applications, choose Help Center from the Help menu.

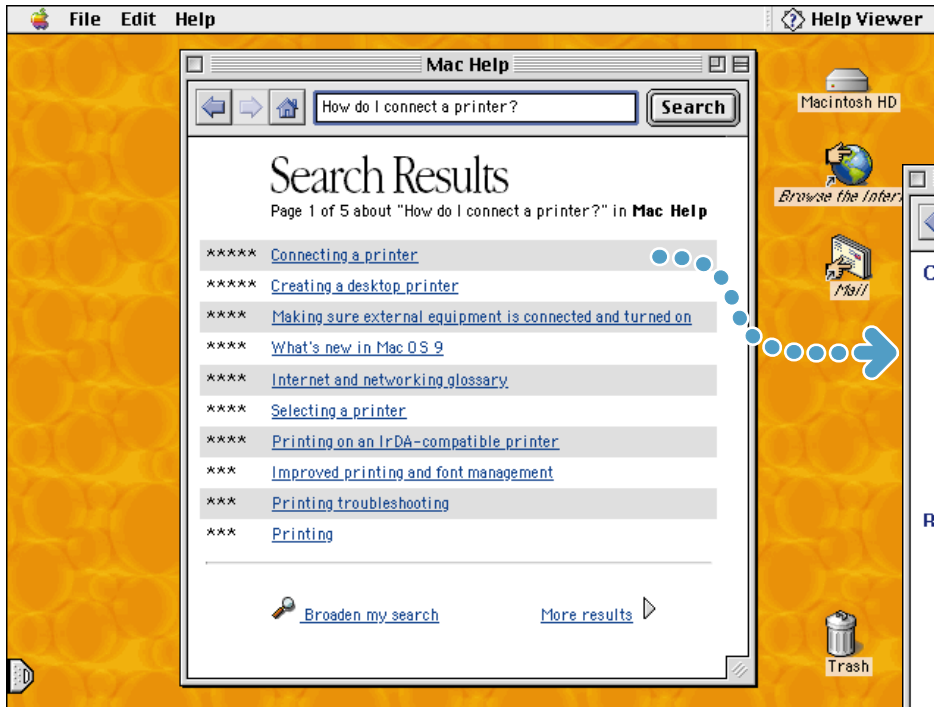

▶ Underlined items are links. When you click a link, it will go to another topic, automatically do something for you, or take you to more information on the Internet.

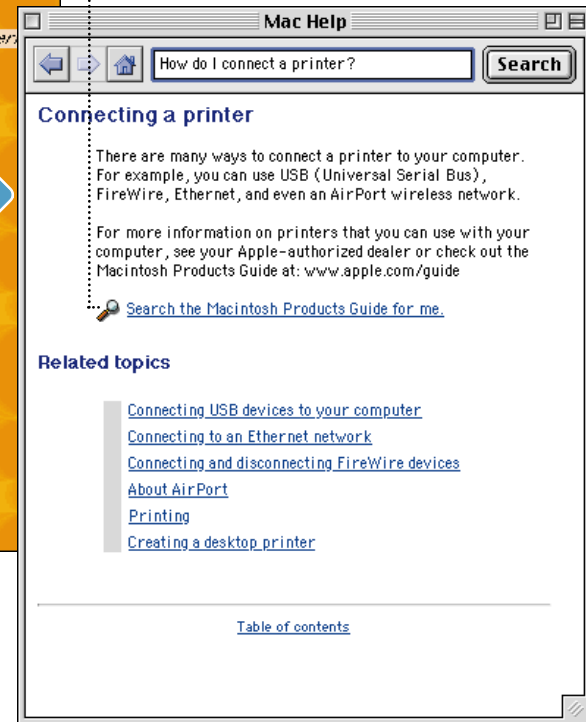

4 Click an item in the list of available Help topics.

▶ If you didn't find what you were looking for, try rewording your question.

What if I have a problem?

If the computer won't respond or the pointer won't move:

First, make sure the mouse and keyboard are connected.

- Unplug and then plug in the connectors and make sure they are firmly seated.

Then try to cancel what the computer is doing.

- Press the Command (⌘) and period (.) keys at the same time. If a dialog box appears, click Cancel.
- If that doesn't work, hold down the Option and Command (⌘) keys, then press the Esc key. If a dialog box appears, click Force Quit. If you return to the Finder (the Finder is checked in the Application menu; see page 4), restart your computer.

If the computer still doesn't respond, restart it.

- Press the Power button on the computer.
- If that doesn't work, hold down the Control and Command (⌘) keys, and then press the Power button on the computer.
- If that doesn't work, press the Reset button (see page 3).
- If that doesn't work, hold down the Power button on the computer for 5 seconds. After your computer turns off, press the Power button on the computer to turn it on again.
- If that doesn't work, unplug the power cord from the computer. Then plug the power cord back in and press the Power button on the computer to turn it on.

Then do this:

If the problem occurs frequently when you use a particular application:

- Check with the application's manufacturer to verify that it is compatible with your computer and the version of system software your computer is using.

If the problem occurs frequently:

- Choose Finder in the Application menu (see page 4). Then open the Help menu and choose Mac Help. Look at the section on how to prevent and solve problems. You may need to check for extension conflicts or reinstall your computer's system software.

If the computer "freezes" during startup or you see a flashing question mark:

Turn off system extensions.

- Start up your computer while holding down the Shift key.

If that does not work, start up using the software install CD.

- Insert the software install CD that came with your computer and start up while holding down the C key. (Make sure the Caps Lock key is not engaged.)

Then do this:

After the computer starts up:

- Make sure that the hard disk that contains the System Folder is selected, or highlighted, in the Startup Disk control panel.
- Then open the Help menu and choose Mac Help. Look at the section on how to prevent and solve problems. You may need to check for extension conflicts or reinstall your computer's system software.

If you notice that the background picture is different:

- You probably started up your computer using the system software on a CD instead of your hard disk. If this is the only way that you startup your computer, you should reinstall the system software on your hard disk. Look for instructions in Mac Help or use the Installer application on your software install CD.

If the computer won't turn on or start up:

First, make sure the power cord is connected.

- The plug on the power cord must be completely inserted into the computer's power socket and firmly seated for your computer to operate correctly. Make sure the power cord is plugged into a working electrical outlet.
- If your computer is plugged into a power strip, make sure the power strip is turned on.

If that does not work, reset your computer.

- Start up the computer and immediately hold down the Command (⌘), Option, P, and R keys until you hear the startup sound a second time. Then release the keys.

If that does not work or if you hear musical tones during startup:

- You may have a problem with RAM (random-access memory). If you recently installed additional memory, make sure that it is correctly installed and that it is compatible with your computer.
- See the service and support information that came with your iMac for information on having your computer serviced.

Other problems

If you have a problem with your dial-up Internet connection:

- Make sure the telephone line is properly connected to your computer and the line is functioning properly.
- Wait a while, then try connecting again.
- Choose Finder in the Application menu (see page 4). Then open the Help menu and choose Mac Help. There you can find your Internet settings and the contact information for your Internet service provider.

If you have a problem with a software program:

- To resolve problems with software, contact the software manufacturer.

If you have a problem using your computer:

- Look at the information in Mac Help for instructions and troubleshooting information.
- Go to the Apple Support Web site on the Internet (www.apple.com/support) for the latest troubleshooting information and software updates.

How do I work comfortably?

The guidelines in this section can help you work more comfortably with your computer. For detailed information about ergonomics, see Apple's Environmental Health and Safety Web site at: www.apple.com/about/ergonomics

Keyboard

- When you use the computer keyboard, your shoulders should be relaxed. Your upper arm and forearm should form an approximate right angle, with your wrist and hand in roughly a straight line.
- You may have to raise your chair so your forearms and hands are at the proper angle to the keyboard. If this makes it impossible to rest your feet flat on the floor, you can use a footrest with adjustable height and tilt to make up for any gap between the floor and your feet. Or you may lower the desktop to eliminate the need for a footrest. Another option is to use a desk with a keyboard tray that is lower than the regular work surface.
- Use a light touch when typing and keep your hands and fingers relaxed. Avoid rolling your thumbs under your palms.

Mouse

- Position the mouse at the same height as your keyboard. Allow adequate space to use the mouse comfortably.

Chair

- An adjustable chair that provides firm, comfortable support is best. Adjust the height of the chair so your thighs are horizontal and your feet flat on the floor.
- The back of the chair should support your lower back (lumbar region). Follow the manufacturer's instructions for adjusting the backrest to fit your body properly.

Computer

- Arrange the computer so the top of the screen is slightly below your eye level when you're sitting at the keyboard. The best distance from your eyes to the screen is up to you, although most people seem to prefer 18 to 28 inches (45 to 70 cm).
- Position the computer to minimize glare and reflections on the screen from overhead lights and windows.

Important Don't lift the computer using the flip-out foot. You could damage your computer. To move your computer, grab the handle on the top of the computer with one hand; with your other hand, hold the bottom of the computer.

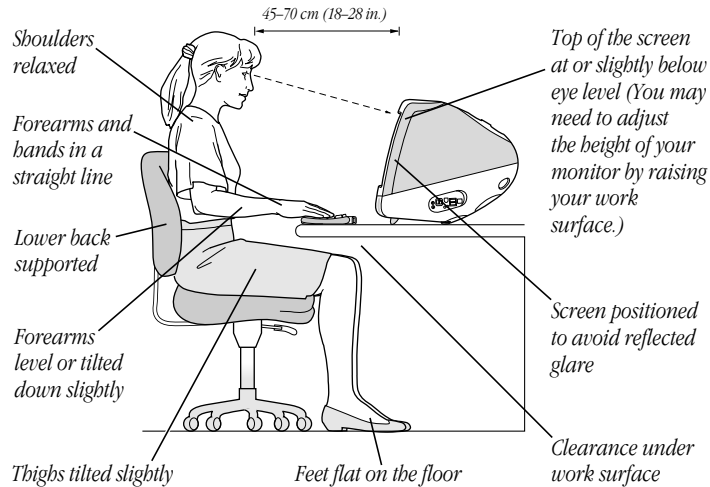

Avoiding fatigue

- Change your seated position, stand up, or stretch whenever you start to feel tired. Frequent short breaks are helpful in reducing fatigue.
- Use a light touch when typing or using a mouse and keep your hands and fingers relaxed.
- Some computer users may develop discomfort in their hands, wrists, or arms after periods of intensive work without breaks. If you begin to develop chronic pain or discomfort in your hands, wrists, or arms, consult a qualified health specialist immediately.
- Allow adequate workspace so that you can use your keyboard and mouse comfortably. Place papers or other items so you can view them easily while using your computer. A document stand may make reading papers more comfortable.
- Eye muscles must work harder to focus on nearby objects. Occasionally focus your eyes on a distant object, and blink often while you work.
- Clean your screen regularly. Keeping the screen clean helps reduce unwanted reflections (see page 27).

Is there anything else I need to know?

Follow these instructions for using your iMac safely and wisely.

Safety

Make sure that you

- keep these instructions handy for reference by you and others who may use your computer
- follow all instructions and warnings regarding your system

When setting up and using your computer, remember the following:

- Place your computer in a location with adequate ventilation. Never block the vents on the computer.
- Your computer has a three-wire grounding plug that will only fit a grounded AC outlet. If you are unable to insert the plug into the outlet, contact a licensed electrician to replace the outlet with a properly grounded outlet.
- Make sure you only connect the modem to an analog phone line, the type commonly used in residences. Do not connect a digital telephone line to the modem, because it could damage the modem.
- Never turn on your computer unless all of its internal and external parts are in place. Operating the computer when it is open or missing parts can be dangerous and damage your computer.

Important The only way to disconnect power completely is to unplug the power cord. Make sure at least one end of the power cord is within easy reach so that you can unplug the computer when you need to.

Warning Electrical equipment may be hazardous if misused. Operation of this product must always be supervised by an adult. Do not allow children access to the interior of this product and do not permit them to handle any cables.

For your own safety and that of your equipment, always disconnect the power plug (by pulling the plug, not the cord) if any of the following conditions exists:

- you want to remove any parts (leave the cord disconnected as long as the computer is open)
- the power cord or plug becomes frayed or otherwise damaged
- you spill something into the case
- your computer is exposed to rain or any other excess moisture
- your computer has been dropped or the case has been otherwise damaged
- you suspect that your computer needs service or repair
- you want to clean the case (use only the recommended procedure discussed in Mac Help)

Be sure that you always do the following:

- Keep your computer away from sources of liquids, such as drinks, washbasins, bathtubs, shower stalls, and so on.
- Protect your computer from dampness or wet weather, such as rain, snow, and so on.

Cleaning your computer equipment

To clean your computer equipment, use only the recommended procedures discussed in Mac Help.

Warning Do not clean the screen with a cleaner that contains alcohol or acetone. Never spray cleaner directly onto the screen. Liquid could drip inside the screen and cause an electrical shock.

Power supply

The power supply in your computer is a high-voltage component and not user-serviceable. If you suspect the power supply needs service, contact your Apple-authorized dealer or service provider.

Warning Do not attempt to access the high-voltage area or power supply. If you suspect the power supply needs service, contact your Apple-authorized dealer or service provider.

Power-saving and environmental features

Your display is equipped with energy-saving features that allow the display to conserve energy when the computer is not in use. For instructions on adjusting the system and display sleep settings and additional energy-conservation information, see Mac Help.

Where's the fine print?

Communications regulation information

FCC compliance statement

This device complies with part 15 of the FCC rules. Operation is subject to the following two conditions: (1) This device may not cause harmful interference, and (2) this device must accept any interference received, including interference that may cause undesired operation. See instructions if interference to radio or television reception is suspected.

Radio and television interference

The equipment described in this manual generates, uses, and can radiate radio-frequency energy. If it is not installed and used properly—that is, in strict accordance with Apple's instructions—it may cause interference with radio and television reception.

This equipment has been tested and found to comply with the limits for a Class B digital device in accordance with the specifications in Part 15 of FCC rules. These specifications are designed to provide reasonable protection against such interference in a residential installation. However, there is no guarantee that interference will not occur in a particular installation.

You can determine whether your computer system is causing interference by turning it off. If the interference stops, it was probably caused by the computer or one of the peripheral devices.

If your computer system does cause interference to radio or television reception, try to correct the interference by using one or more of the following measures:

- Turn the television or radio antenna until the interference stops.
- Move the computer to one side or the other of the television or radio.
- Move the computer farther away from the television or radio.
- Plug the computer into an outlet that is on a different circuit from the television or radio. (That is, make certain the computer and the television or radio are on circuits controlled by different circuit breakers or fuses.)

If necessary, consult an Apple-authorized service provider or Apple. See the service and support information that came with your Apple product. Or, consult an experienced radio/television technician for additional suggestions.

Changes or modifications to this product not authorized by Apple Computer, Inc., could void the FCC Certification and negate your authority to operate the product.

Important This product was tested for FCC compliance under conditions that included the use of Apple peripheral devices and Apple shielded cables and connectors between system components. It is important that you use Apple peripheral devices and shielded cables and connectors between system components to reduce the possibility of causing interference to radios, television sets, and other electronic devices. You can obtain Apple peripheral devices and the proper shielded cables and connectors through an Apple-authorized dealer. For non-Apple peripheral devices, contact the manufacturer or dealer for assistance.

Responsible party (contact for FCC matters only): Apple Computer, Inc., Product Compliance, 1 Infinite Loop M/S 26-A, Cupertino, CA 95014-2084, 408-974-2000.

Exposure to radio frequency energy

The radiated output power of the optional AirPort Card is far below the FCC radio frequency exposure limits. Nevertheless, it is advised to use the wireless equipment in such a manner that the potential for human contact during normal operation is minimized.

Industry Canada statement

This Class B device meets all requirements of the Canadian interference-causing equipment regulations.

Cet appareil numérique de la Class B respecte toutes les exigences du Règlement sur le matériel brouilleur du Canada.

Europe-EU Declaration of Conformity

This device complies with the specifications ETS 300 328 and ETS 300 286, following the provisions of the EMC Directive 89/336/EEC.

VCCI Class 2 statement

情報処理装置等電波障害自主規制について

この装置は、情報処理装置等電波障害自主規制協議会（VCCI）の基準に基づくクラス B 情報技術装置です。この装置は、家庭環境で使用することを目的としていますが、この装置がラジオやテレビジョン受信機に近接して使用されると、受信障害を引き起こすことがあります。

取扱説明書に従って正しい取り扱いをして下さい。

Telephone and modem information

Some telephone companies require that you notify the local business office when you hook up a modem to their lines.

Information you need in the United States

The internal modem complies with Part 68 of the FCC rules. On the back of this equipment is a label that contains, among other information, the FCC registration number and ringer equivalence number (REN). If requested, provide this information to your telephone company.

- *Ringer equivalence number (REN)*: 0.8–0.9 The REN is useful to determine the quantity of devices you may connect to your telephone lines and still have all those devices ring when your telephone number is called. In most, but not all areas, the sum of the RENs of all devices connected to one line should not exceed five (5.0). To be certain of the number of devices you may connect to your line, as determined by the REN, you should contact your local telephone company to determine the maximum REN for your calling area.
- *Telephone jack type*: USOC, RJ-11 An FCC-compliant telephone cord and modular plug are provided with this equipment. This equipment is designed to be connected to the telephone network or premises wiring using a compatible modular jack that complies with Part 68 rules. See the installation instructions for details.

Telephone line problems

If your telephone doesn't work, there may be a problem with your telephone line. Disconnect the modem to see if the problem goes away. If it doesn't, report the problem either to your local telephone company or to your company's telecommunications people.

If disconnecting the modem eliminates the problem, the modem itself may need service. See the service and support information that came with your Apple product for instructions on how to contact Apple or an Apple-authorized service provider for assistance.

If you do not disconnect your modem when it is adversely affecting the telephone line, the telephone company has the right to disconnect your service temporarily until you correct the problem. The telephone company will notify you as soon as possible. Also, you will be informed of your right to file a complaint with the FCC.

The telephone company may make changes in its facilities, equipment, operations, or procedures that could affect the operation of your equipment. If this happens, the telephone company will provide advance notice in order for you to make the necessary modifications to maintain uninterrupted service.

The optional internal modem will not work with party lines, cannot be connected to a coin-operated telephone, and may not work with a private branch exchange (PBX).

Telephone Consumer Protection Act

The Telephone Consumer Protection Act of 1991 makes it unlawful for any person to use a computer or other electronic device to send any message via a telephone fax machine unless such message clearly contains in a margin at the top or bottom of each transmitted page or on the first page of the transmission, the date and time it was sent and an identification of the business or other entity, or individual sending the message and the telephone number of the sending machine of such business, entity, or individual.

Information you need in Canada

The Industry Canada (IC) label identifies certified equipment. This certification means that the equipment meets certain telecommunications network protective, operational, and safety requirements. The Department does not guarantee the equipment will operate to a user's satisfaction.

Before installing this equipment, make sure that you are permitted to connect to the facilities of the local telecommunications company. Be sure you use an acceptable method of connection to install the equipment. In some cases, you may extend the company's internal wiring for single-line individual service by means of a certified telephone extension cord. Be aware, however, that compliance with these conditions may not prevent degradation of service in some situations.

Repairs to certified equipment should be made by an authorized Canadian maintenance facility designated by the supplier. Any equipment malfunctions or repairs or alterations that you make to this equipment may cause the telecommunications company to request that you disconnect the equipment.

In Canada, contact Apple at: 7495 Birchmount Road, Markham, Ontario, L3R 5G2, 800-263-3394

Users should ensure for their own protection that the electrical ground connections of the power utility, telephone lines, and internal metallic water pipe system, if present, are connected together. This precaution may be particularly important in rural areas.

Warning Users should not attempt to make such connections themselves, but should contact the appropriate electric inspection authority or electrician.

- **Load number:** 0.3 The load number (LN) assigned to each terminal device denotes the percentage of the total load to be connected to the telephone loop that is used by the device, to prevent overloading. The termination of a loop may consist of any combination of devices, subject only to the requirement that the sum of the load numbers of all devices does not exceed 100.
- **Telephone jack type:** CA-11

Informations destinés aux utilisateurs Canadiens

L'étiquette d'Industrie Canada identifie un matériel homologué. Cette étiquette certifie que le matériel est conforme à certaines normes de protection, d'exploitation et de sécurité des réseaux de télécommunications. Le Ministère n'assure toutefois pas que le matériel fonctionnera à la satisfaction de l'utilisateur.

Avant d'installer ce matériel, l'utilisateur doit s'assurer qu'il est permis de le raccorder au réseau de l'entreprise locale de télécommunication. Le matériel doit également être installé en suivant une méthode acceptée de raccordement. Dans certains cas, le cablage appartenant à l'entreprise utilisé pour un service individuel à ligne unique peut être prolongé au moyen d'un dispositif homologué de raccordement (cordon prolongateur téléphonique).

L'abonné ne doit pas oublier qu'il est possible que la conformité aux conditions énoncées ci-dessus n'empêchent pas la dégradation du service dans certaines situations. De fait, les entreprises de télécommunication ne permettent pas que l'on raccorde un matériel aux prises d'abonné, sauf dans les cas précis prévus par les tarifs particuliers de ces entreprises.

Les réparations de matériel homologué doivent être effectuées par un centre d'entretien canadien autorisé désigné par le fournisseur. La compagnie de télécommunications peut demander à l'utilisateur de débrancher un appareil suite à des réparations ou des modifications effectuées par l'utilisateur ou à cause de mauvais fonctionnement.

Veillez contacter le fournisseur suivant pour des informations supplémentaires :

Apple Canada, Inc.
7495 Birchmount Road
Markham, Ontario
Canada L3R 5G2
Apple Canada Customer Assistance Line: 800-263-3394

Pour sa propre protection, l'utilisateur doit s'assurer que tous les fils de mise à la terre du secteur, des lignes téléphoniques et les canalisations d'eau métalliques, s'il y en a, soient raccordés ensemble. Cette précaution est particulièrement importante dans les régions rurales.

Avertissement L'utilisateur ne doit pas tenter de faire ces raccordements lui-même; il doit avoir recours à un service d'inspection des installations électriques ou à un électricien, selon le cas.

- **Numéro de charge :** 0.3 L'indice de charge (IC) assigné à chaque dispositif terminal indique, pour éviter toute surcharge, le pourcentage de la charge totale qui sera raccordée à un circuit téléphonique bouclé utilisé par ce dispositif. La terminaison du circuit bouclé peut être constituée de n'importe quelle combinaison de dispositifs pourvu que la somme des indices de charge de l'ensemble des dispositifs ne dépasse pas 100.
- **Type de prise téléphonique :** CA-11

Information you need in the United Kingdom

This terminal equipment is intended for direct connection to the analogue Public Switched Telecommunications Network and is approved for use within the United Kingdom with the following features:

- Modem facility
- Autocalling facility
- Autoanswer facility
- DTMF signaling
- Operation in the absence of proceed indication or upon detection of proceed indication

This product is in conformity with relevant regulatory standards following the provisions of European Council Directives 73/23/EEC (Low Voltage Directive) and 89/336/EEC amended by 92/31/EEC (EMC Directive).

Information you need in Germany

Diese Modem-Karte ist als Endeinrichtung vorgesehen und muss an ein TAE mit F-Kodierung angeschlossen werden.

Diese Endeinrichtung ist in Konformität gemäss Niederspannungsrichtlinie 73 / 23 / EWG sowie EMC-Richtlinien

89 / 336 / EWG und 92 / 31 / EWG.

Information you need in France

Ce matériel est conforme aux normes applicables de sécurité électrique d'après la directive 73 / 23 / CEE et aux normes applicables de comptabilité électromagnétique d'après la directive 89 / 336 / CEE, modifié par la directive 92 / 31 / CEE.

Information you need in Australia

All telecommunications devices are required to be labelled as complying to the Australian telecommunications standards, ensuring the health and safety of the operator and the integrity of the Australian telecommunications network. To provide compliance with the Australian Communications Authority's technical standards, please ensure that the following AT commands are maintained:

- ATB0 (ITU/CCITT operation)
- AT&G0 (no guard tone)
- AT&P1 (33/66 pulse dial make/break ratio)
- ATS0 = 0 or ATS0 = 1 (no answer or answer greater than one ring)
- ATS6 = 95 (DTMF period between 70–255 ms)
- ATS11 = 95 (DTMF period between 70–255 ms)

For calls that are automatically generated, a total of three call attempts are allowed to a telephone number, with a minimum period between calls of 2 seconds. If the call does not connect after three attempts, 30 minutes must expire before automatic redialing may be initiated. Failure to set the modem (and any associated communications software) to the above settings may result in the modem being non-compliant with Australian telecommunications standards. Under these circumstances a user could be subject to significant penalties under the Telecommunications Act 1997.

This modem must be properly secured in order for you to use it. Telecommunications network voltages exist inside the computer and the telecommunications line connection must be removed before opening the computer.

Information you need in New Zealand

This modem is fully approved to operate on the New Zealand telecommunications network under Telepermit number PTC 211/98/119. All telecommunications devices are required to hold a Telepermit and be labelled accordingly with the approved Telepermit number to comply with the New Zealand telecommunications standards, ensuring the health and safety of the operator and the integrity of the New Zealand telecommunications network.

Customers in New Zealand who are prompted to choose a country for their modem should choose the "Australia" country code setting.

To ensure compliance, all calls that are automatically generated should not make more than 10 call attempts to the same number within any 30 minute period with a minimum period between calls of 30 seconds. Failure to adhere to these standards may result in the modem being non-compliant with New Zealand Telecom standards. Under these circumstances a user could be subject to significant penalties.

If pulse dialing is required for any reason, the communications software must be set up to record numbers according to the following translation list.

- Number to be dialed: 0; number to be entered into computer: 0
- Number to be dialed: 1; number to be entered into computer: 9
- Number to be dialed: 2; number to be entered into computer: 8
- Number to be dialed: 3; number to be entered into computer: 7
- Number to be dialed: 4; number to be entered into computer: 6
- Number to be dialed: 5; number to be entered into computer: 5
- Number to be dialed: 6; number to be entered into computer: 4
- Number to be dialed: 7; number to be entered into computer: 3
- Number to be dialed: 8; number to be entered into computer: 2
- Number to be dialed: 9; number to be entered into computer: 1
- Number to be dialed: 0; number to be entered into computer: 0

The preferred method of dialing is to use DTMF tones as this is faster than pulse (decadic) dialing and is readily available on almost all New Zealand telephone exchanges.

Laser information

Warning Making adjustments or performing procedures other than those specified in your equipment's manual may result in hazardous radiation exposure.

Do not attempt to disassemble the cabinet containing the laser. The laser beam used in this product is harmful to the eyes. The use of optical instruments, such as magnifying lenses, with this product increases the potential hazard to your eyes. For your safety, have this equipment serviced only by an Apple-authorized service provider.

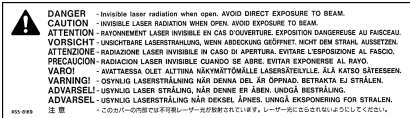

Service warning label

High-risk activities warning

This computer system is not intended for use in the operation of nuclear facilities, aircraft navigation or communications systems, or air traffic control machines, or for any other uses where the failure of the computer system could lead to death, personal injury or severe environmental damage.

Mouse information

This product complies with the requirements of European Directives 72/23/EEC and 89/336/EEC. Complies with the Canadian ICES-003 Class B specification.

ENERGY STAR

As an ENERGY STAR® partner, Apple Computer has determined that this product meets the ENERGY STAR guidelines for energy efficiency. The United States Environmental Protection Agency's ENERGY STAR program is a partnership with office product equipment manufacturers to promote energy-efficiency. Reducing energy consumption of office products saves money and reduces pollution by eliminating wasted energy.

Every effort has been made to ensure that the information in this manual is accurate. Apple is not responsible for printing or clerical errors.